

Características Gerais

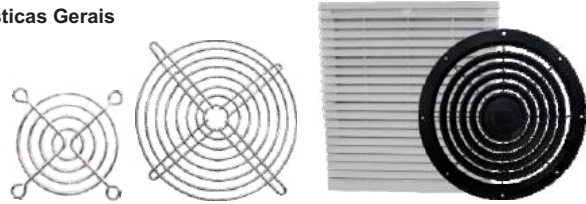

	Grade	Persiana/Filtro
Material	Metálico	Termoplástico
Estrutura	Redondo	Quadrado/Redondo
Cor	Cromado	Cinza/Preto

Aplicações

Proteção para microventiladores. Grade para prevenção de contato com a hélice e persiana+filtro para minimizar a entrada de partículas em suspensão contido no ar.

Grade Metálica

Código	Referência
16064	Grade 60x60
13536	Grade 80x80
13537	Grade 120x120
13538	Grade 150x150
13539	Grade 180x180
15511	200 22580FZY
15512	TA28080 250FZY
15513	300 300FZY

Persiana / Filtro

Código	Referência
15514	9806
15515	25489
13540	FK772230
13541	FK9803
13542	FK9804
13543	FK9805

Dimensões

Grade 60x60

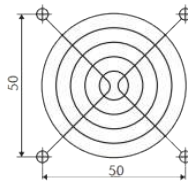

Grade 80x80

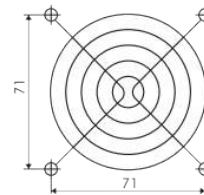

Grade 120x120

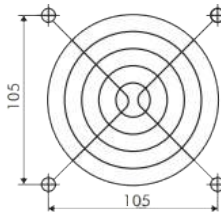

Grade 150x150

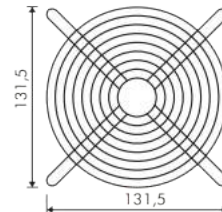

Grade 180x180

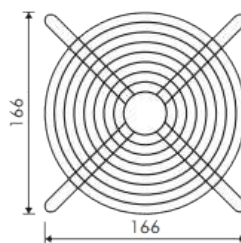

200 22580FZY

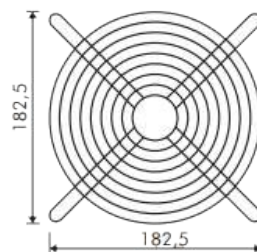

TA28080 250FZY

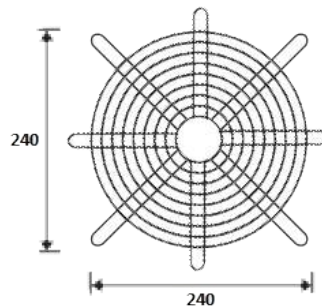

300 300FZY

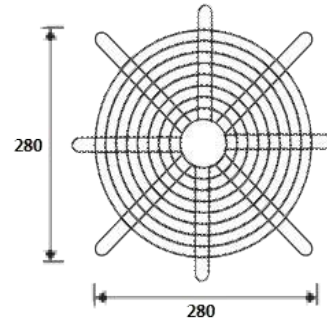

► Dimensões

FK772230

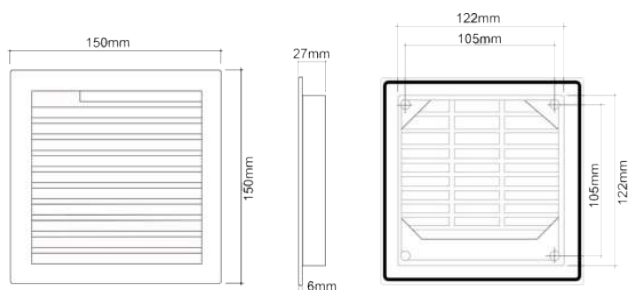

Microventilador 120x120

FK9803

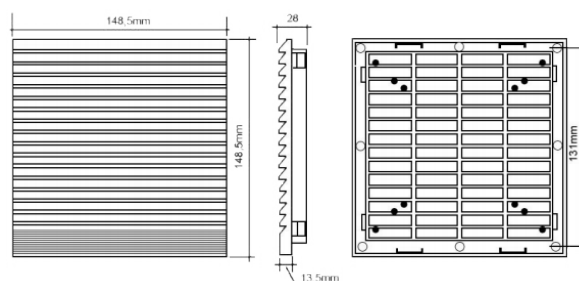

Microventilador 80x80
120x120

FK9804

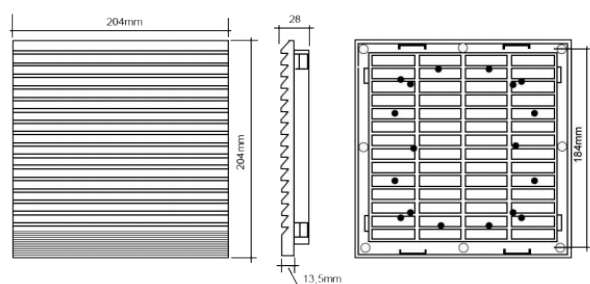

Microventilador 120x120
150x150
170x150

FK9805

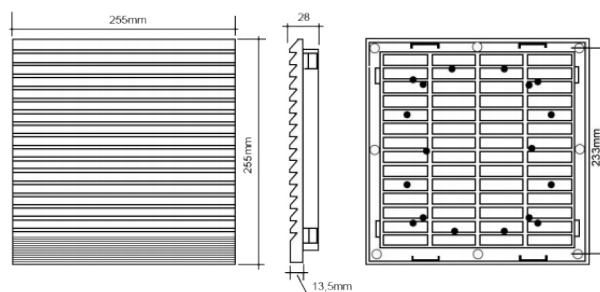

Microventilador 180x180
200x200
220x220
225x225

9806

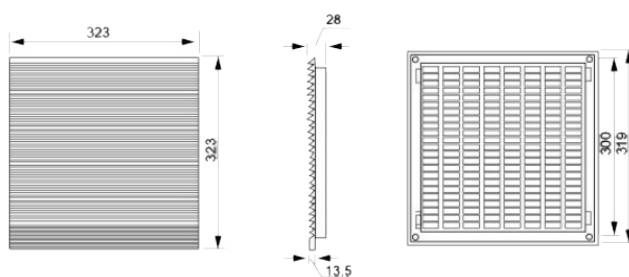

Microventilador 225x225
254x254

25489

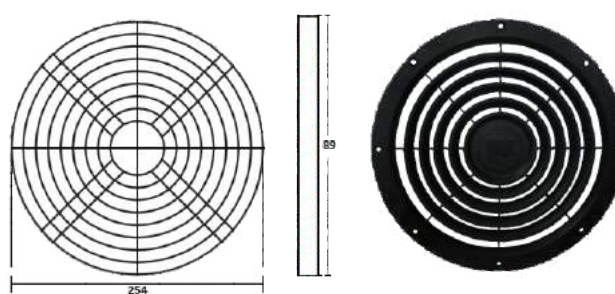

Microventilador 254x254